



KTVP-750 Series

Vortex Flow meter with Temperature and Pressure Compensation

FEATURE

- 온도, 압력, 유량센서 일체화로 정밀도가 우수
- 설치 비용과 유지관리 비용이 타사 제품에 비해 획기적으로 낮음
- 플랜지 또는 공간 절약용 웨이퍼 타입 선택 가능
- Connection Size 대비 Tube Size 줄이기 가능
- 구동 부품이 없어 내구성이 우수하며 수명이 김
- 액체, 기체, 스팀 등 다양한 유체에 적용 가능
- 측정 유량 범위가 높고 상대적으로 적은 압력 손실

APPLICATIONS

- ▶ 일반적인 적용 분야
- 유틸리티 용도 : 에너지 분배로 사용되는 보조 및 공급 라인
- ▶ 화학 및 기타 공정 산업
- 가스, 용접 가스, 증기, 탄화 수소(hydrocarbon), 열 오일 등
- 석유 화학 제품(벤젠, 에틸렌 등)
- ▶ 철, 강철 및 금속 산업
- 냉각 회로 산소, 천연 가스, 증기
- ▶ 하수 산업, 재생 에너지 산업
- CHP(복합 난방 및 전력)시스템 입구의 건조 및 습한 바이오 가스
- ▶ 제지업
- 압축 공기, 증기 등

KTVP-750 General Specifications

Size	15A (1/2") - 300A (12")
Process Connection	Flange type - Standard JIS10K RF (Option. ANSI 150#, DIN 16 bar) Wafer type
Measuring Range	Water - 0.7 m ³ /h – 1800 m ³ /h Gas - 3.5 Nm ³ /h – 11000 Nm ³ /h
Accuracy	±1.0 % F.S (Option ±0.5 %)
Fluid Temperature	-40 °C ~ 250 °C (Option 350 °C)
Ambient Temperature	-25 °C ~ 60 °C
Max Pressure	20 kgf/cm ² .G (Option 40 kgf/cm ² .G)
Power Supply	DC 24 V (2-Wire)
Display	LCD Display (Flowrate, Totalizer, Temperature, Pressure)
Output	DC 4-20 mA, Pulse (Option RS-485)
Protection Class	Ex d IIC T5 / IP67

MODEL CODE

KTVP-750	-	□	-	□	Specification
		F			Connection - Flange Type
		W			Connection - Wafer Type
				EX	Ex d IIC T5 / IP67

STRUCTURAL DRAWING

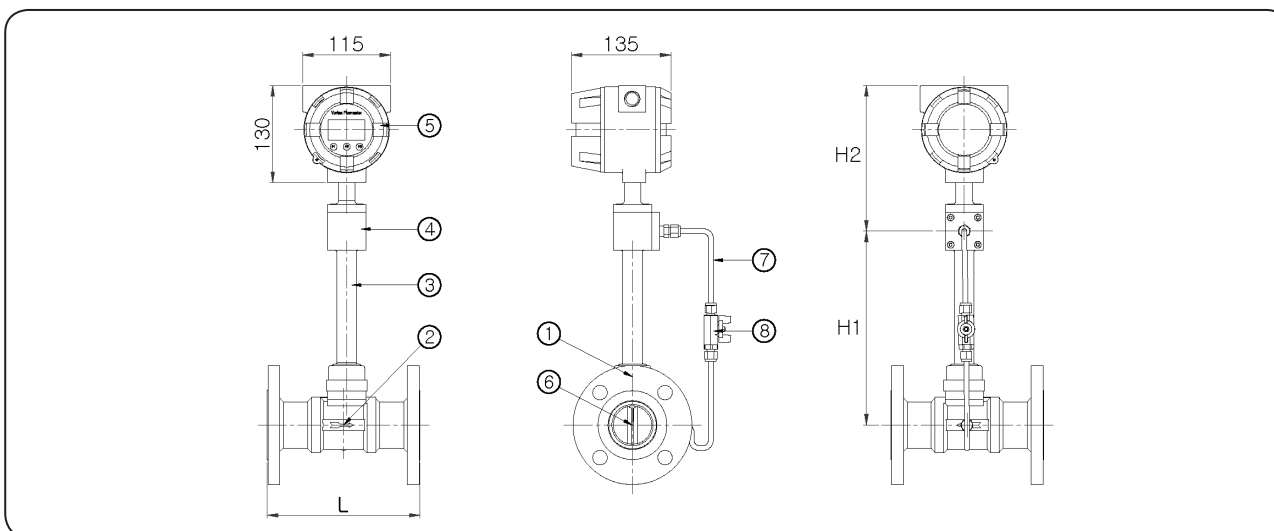

DIMENSIONS

Size		L	H1	H2
mm	inch			
15	1/2"	200	200	195
20	3/4"	200		
25	1"	200		
40	1-1/2"	200		
50	2"	200		
65	2-1/2"	200	220	
80	3"	200		
100	4"	250	240	
125	5"	250	250	
150	6"	300	260	
200	8"	350	300	
250	10"	400	320	
300	12"	500	340	

* Height (H1, H2)는 사양에 따라 변경될 수 있음.

STANDARD MATERIAL

No.	Description	Material	
		A	B
1	Flange	304SS	316SS
2	Body	304SS	316SS
3	Bar	304SS	
4	Press' Sensor Housing	304SS	316SS
5	Indicator	CAST ALUMINUM	
6	Flow & Temp' Sensor	304SS	316SS
7	Press' Tube	316SS	
8	Valve	304SS	

NORMAL FLOW RANGES

Size		Water (m ³ /h)	Gas (Nm ³ /h) *1 atm / 20°C 기준
mm	inch		
15	1/2"	0.7 - 7	3.5 - 35
20	3/4"	1 - 10	5 - 50
25	1"	1.6 - 16	7 - 70
40	1-1/2"	2.5 - 25	22 - 220
50	2"	3.5 - 35	32 - 320
65	2-1/2"	6.8 - 68	48 - 480
80	3"	10 - 100	64 - 640
100	4"	15 - 150	110 - 1100
125	5"	27.5 - 275	170 - 1700
150	6"	40 - 400	224 - 2240
200	8"	80 - 800	496 - 4960
250	10"	120 - 1,200	800 - 8000
300	12"	180 - 1,800	1100 - 11000

■ GAS FLOW RANGES

Size		Max. Flow ranges (Nm ³ /h) (1 atm/20 °C)					
mm	inch	1 kg/cm ² .G	2 kg/cm ² .G	4 kg/cm ² .G	6 kg/cm ² .G	8 kg/cm ² .G	10 kg/cm ² .G
15	1/2"	80	110	180	250	310	380
20	3/4"	110	150	250	350	440	540
25	1"	150	210	350	480	620	760
40	1-1/2"	440	650	1080	1510	1930	2360
50	2"	630	950	1570	2190	2810	3420
65	2-1/2"	950	1420	2350	3270	4200	5130
80	3"	1270	1890	3130	4360	5600	6840
100	4"	2170	3240	5370	7500	9620	11750
125	5"	3350	5000	8290	11580	14870	18160
150	6"	4420	6580	10920	15260	19590	23930
200	8"	9770	14570	24170	33770	43370	52970
250	10"	15750	23490	38980	54470	69950	85440
300	12"	21650	32300	53590	74890	96180	117470

■ SATURATED STEAM FLOW RANGES

Size		Max. Flow ranges (kg/h)					
mm	inch	1 kg/cm ² .G	2 kg/cm ² .G	4 kg/cm ² .G	6 kg/cm ² .G	8 kg/cm ² .G	10 kg/cm ² .G
15	1/2"	39	57	92	126	160	194
20	3/4"	55	81	131	180	229	277
25	1"	78	113	183	252	320	387
40	1-1/2"	244	357	577	792	1005	1217
50	2"	355	519	839	1152	1462	1771
65	2-1/2"	532	778	1258	1728	2194	2656
80	3"	710	1037	1677	2304	2925	3542
100	4"	1220	1783	2883	3960	5027	6087
125	5"	1885	2756	4456	6120	7769	9408
150	6"	2484	3631	5871	8064	10237	12396
200	8"	5501	8040	13000	17856	22667	27449
250	10"	8872	12968	20968	28800	36560	44272
300	12"	12199	17831	28831	39600	50270	60874

DRAWING OF INSTALLATION

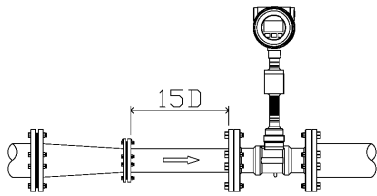
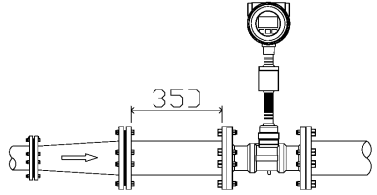
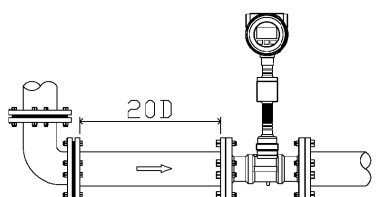
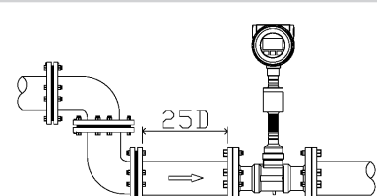
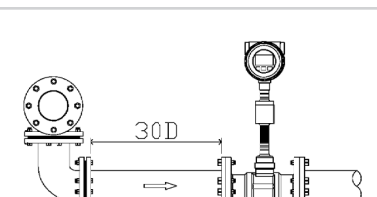
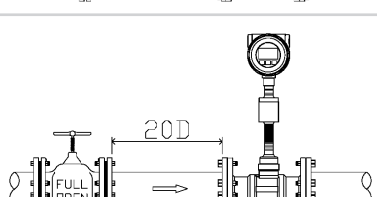
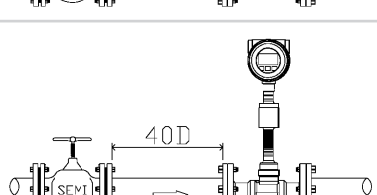
Classification	Upstream Pipe style	Length of straight Pipeline Inlet	Length of straight Pipeline Outlet
Concentric Shrink tube (동심축소관)		15D	7D
Concentric Enlarge tube (동심확대관)		35D	17D
Elbow		20D	10D
Two Same Plane elbow		25D	12D
Two Different Plane elbow		30D	15D
Full Open Valve		20D	10D
Semi Open Valve		40D	20D



KTV-700 Series

Vortex Flow meter with
All Fluid Measurements

FEATURE

- 설치 비용과 유지관리 비용이 타사 제품에 비해 획기적으로 낮음
- 플랜지 또는 공간 절약용 웨이퍼 타입 선택 가능
- Connection Size 대비 Tube Size 줄이기 가능
- 구동 부품이 없어 내구성이 우수하며 수명이 김
- 액체, 기체, 스팀 등 다양한 유체에 적용 가능
- 측정 유량 범위가 높고 상대적으로 적은 압력 손실

APPLICATIONS

- ▶ 일반적인 적용 분야
 - 유틸리티 용도 : 에너지 분배로 사용되는 보조 및 공급 라인
- ▶ 화학 및 기타 공정 산업
 - 가스, 용접 가스, 증기, 탄화 수소(hydrocarbon), 열 오일 등
 - 석유 화학 제품(벤젠, 에틸렌 등)
- ▶ 철, 강철 및 금속 산업
 - 냉각 회로 산소, 천연 가스, 증기
- ▶ 하수 산업, 재생 에너지 산업
 - CHP(복합 난방 및 전력)시스템 입구의 건조 및 습한 바이오 가스
- ▶ 제지업
 - 압축 공기, 증기 등

■ KTV-700 General Specifications

Size	15A (1/2") - 300A (12")
Process Connection	Flange type - Standard JIS10K RF (Option. ANSI 150#, DIN 16 bar) Wafer type
Measuring Range	Water - 0.7 m ³ /h – 1800 m ³ /h Gas - 3.5 Nm ³ /h – 11000 Nm ³ /h
Accuracy	±1.0 % F.S (Option ±0.5 %)
Fluid Temperature	-40 °C ~ 250 °C (Option 350 °C)
Ambient Temperature	-25 °C ~ 60 °C
Max Pressure	20 kgf/cm ² .G (Option 40 kgf/cm ² .G)
Power Supply	DC 24 V (2-Wire)
Display	LCD Display (Flowrate, Totalizer, Temperature, Pressure)
Output	DC 4-20 mA, Pulse (Option RS-485)

■ MODEL CODE

K T V - 7 0 0	-	□	-	□	Specification
		F			Connection - Flange Type
		W			Connection - Wafer Tpye

■ STRUCTURAL DRAWING

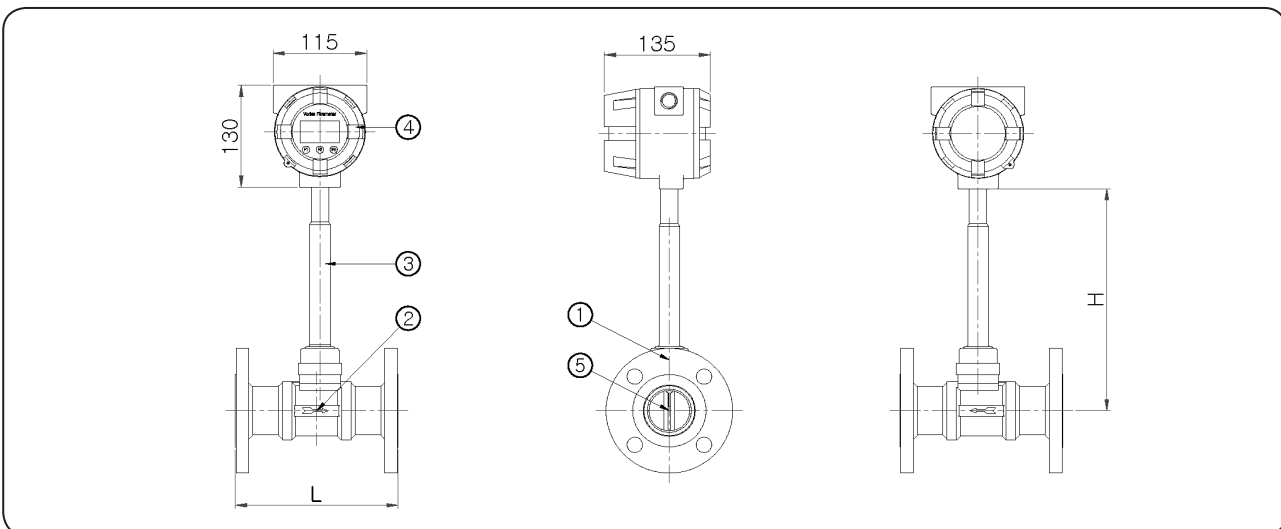

DIMENSIONS

Size		L	H1	H2
mm	inch			
15	1/2"	200	200	195
20	3/4"	200		
25	1"	200		
40	1-1/2"	200		
50	2"	200		
65	2-1/2"	200	220	
80	3"	200		
100	4"	250	240	
125	5"	250	250	
150	6"	300	260	
200	8"	350	300	
250	10"	400	320	
300	12"	500	340	

* Height (H1, H2)는 사양에 따라 변경될 수 있음.

STANDARD MATERIAL

No.	Description	Material	
		A	B
1	Flange	304SS	316SS
2	Body	304SS	316SS
3	Bar	304SS	
4	Indicator	CAST ALUMINUM	
5	Flow Sensor	304SS	316SS

NORMAL FLOW RANGES

Size		Water (m ³ /h)	Gas (Nm ³ /h) *1 atm / 20°C 기준
mm	inch		
15	1/2"	0.7 - 7	3.5 - 35
20	3/4"	1 - 10	5 - 50
25	1"	1.6 - 16	7 - 70
40	1-1/2"	2.5 - 25	22 - 220
50	2"	3.5 - 35	32 - 320
65	2-1/2"	6.8 - 68	48 - 480
80	3"	10 - 100	64 - 640
100	4"	15 - 150	110 - 1100
125	5"	27.5 - 275	170 - 1700
150	6"	40 - 400	224 - 2240
200	8"	80 - 800	496 - 4960
250	10"	120 - 1,200	800 - 8000
300	12"	180 - 1,800	1100 - 11000

■ GAS FLOW RANGES

Size		Max. Flow ranges (Nm ³ /h) (1 atm/20 °C)					
mm	inch	1 kg/cm ² .G	2 kg/cm ² .G	4 kg/cm ² .G	6 kg/cm ² .G	8 kg/cm ² .G	10 kg/cm ² .G
15	1/2"	80	110	180	250	310	380
20	3/4"	110	150	250	350	440	540
25	1"	150	210	350	480	620	760
40	1-1/2"	440	650	1080	1510	1930	2360
50	2"	630	950	1570	2190	2810	3420
65	2-1/2"	950	1420	2350	3270	4200	5130
80	3"	1270	1890	3130	4360	5600	6840
100	4"	2170	3240	5370	7500	9620	11750
125	5"	3350	5000	8290	11580	14870	18160
150	6"	4420	6580	10920	15260	19590	23930
200	8"	9770	14570	24170	33770	43370	52970
250	10"	15750	23490	38980	54470	69950	85440
300	12"	21650	32300	53590	74890	96180	117470

■ SATURATED STEAM FLOW RANGES

Size		Max. Flow ranges (kg/h)					
mm	inch	1 kg/cm ² .G	2 kg/cm ² .G	4 kg/cm ² .G	6 kg/cm ² .G	8 kg/cm ² .G	10 kg/cm ² .G
15	1/2"	39	57	92	126	160	194
20	3/4"	55	81	131	180	229	277
25	1"	78	113	183	252	320	387
40	1-1/2"	244	357	577	792	1005	1217
50	2"	355	519	839	1152	1462	1771
65	2-1/2"	532	778	1258	1728	2194	2656
80	3"	710	1037	1677	2304	2925	3542
100	4"	1220	1783	2883	3960	5027	6087
125	5"	1885	2756	4456	6120	7769	9408
150	6"	2484	3631	5871	8064	10237	12396
200	8"	5501	8040	13000	17856	22667	27449
250	10"	8872	12968	20968	28800	36560	44272
300	12"	12199	17831	28831	39600	50270	60874

DRAWING OF INSTALLATION

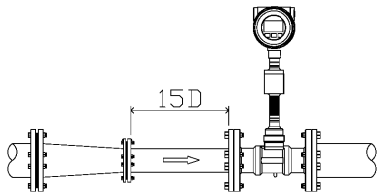
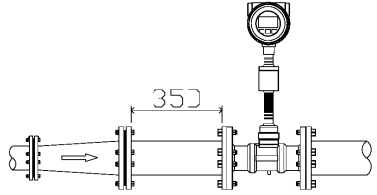
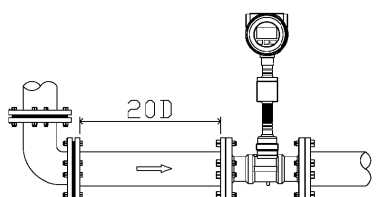
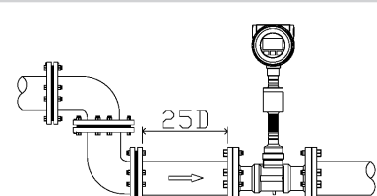
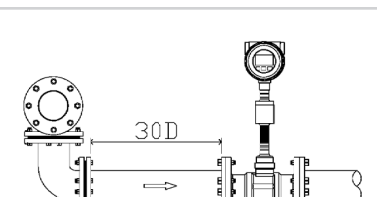
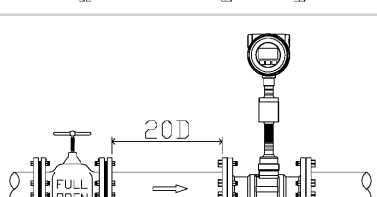
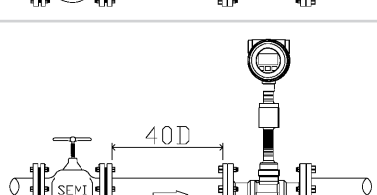
Classification	Upstream Pipe style	Length of straight Pipeline Inlet	Length of straight Pipeline Outlet
Concentric Shrink tube (동심축소관)		15D	7D
Concentric Enlarge tube (동심확대관)		35D	17D
Elbow		20D	10D
Two Same Plane elbow		25D	12D
Two Different Plane elbow		30D	15D
Full Open Valve		20D	10D
Semi Open Valve		40D	20D